

# MT-1/WT1

HIGH ACCURACY SINGLE-PHASE  
WIRELESS WATTHOUR METER TESTER



## USER'S GUIDE



---

# MT-1/WT1

## User Guide

Version 2.1 – March 2021



**IT IS ESSENTIAL THAT OPERATORS THOROUGHLY READ THIS INSTRUCTION  
MANUAL BEFORE PUTTING THIS PRODUCT INTO SERVICE.**

© Copyright 2021 by Probewell Lab Inc. Printed in Canada.

All rights reserved, including those to reproduce this manual or parts thereof, in any form without the express written permission of Probewell Lab Inc.

## Limited Warranty

Your MT-1/WT1 comes with a two-year hardware warranty. Probewell Lab Inc. (Probewell) warrants this MT-1/WT1 against defects in materials and workmanship for a period of two (2) years from the date of purchase from Probewell. This warranty applies only to the original purchaser of the MT-1/WT1 and is not transferable.

All accessories come with a two-year hardware warranty. Probewell warrants all accessories against defects in materials and workmanship for a period of two (2) years from the date of purchase from Probewell. This warranty applies only to the original purchaser and is not transferable.

This warranty does not cover any damages caused either by negligence, non-authorized modifications, or parts installed without prior written permission from Probewell.

This warranty does not apply if the product has been damaged by accident, abuse, misuse, or misapplication, nor as a result of service to the product by anyone other than Probewell.

PROBEWELL IS NOT RESPONSIBLE FOR ANY LOST PROFITS, LOST SAVINGS OR OTHER INCIDENTAL OR CONSEQUENTIAL DAMAGES ARISING OUT OF THE USE OF OR THE INABILITY TO USE THIS PRODUCT. THIS INCLUDES DAMAGE TO PROPERTY AND DAMAGES FOR PERSONAL INJURY. THIS WARRANTY IS IN LIEU OF ALL OTHER WARRANTIES, INCLUDING IMPLIED WARRANTIES OF MERCHANTABILITY AND FITNESS FOR A PARTICULAR PURPOSE.

## Disclaimer

Probewell Lab Inc., (Probewell) reserves the right to make changes to this document and to the products it describes without notice. Probewell shall not be liable for technical or editorial errors or omissions made herein; nor for incidental or consequential damages resulting from the furnishing, performance, or use of this material.

Features and specifications are subject to change without notice.

# Table of Contents

<b>Introduction</b> .....	7
MT-1/WT1 Overview .....	7
<b>Description</b> .....	9
MT-1/WT3 Socket .....	9
Front/Rear View of the Socket .....	10
Side View of the Socket .....	11
Theory of Operation .....	13
Meter Testing .....	15
Accessories .....	17
Metercam .....	17
Optical Pickup .....	18
Meter Adapters .....	19
<b>Operation</b> .....	21
Summary .....	22
Installing the Socket .....	23
Connecting to the MT-1/WT1 .....	25
Running the Application .....	25
Available Tests .....	26
Test Examples .....	27
Example 1: Quick Test – Solid-State 2S Meter .....	28
Example 2: Custom Test – Solid-State 12S Meter .....	30
Example 3: Tracking Test – 12S(N) Meter .....	31
Example 4: Custom Test – 2S Electromechanical Meter .....	33
Example 5: Meter Tested in the Meter Shop .....	35
<b>Appendix A</b>	
Specifications .....	37
<b>Appendix B</b>	
Compatible Meter Forms .....	41
Form 1S .....	42
Form 2S .....	43
Form 3S .....	44
Form 4S .....	45
Form 5S(N) (N 2CT) .....	46
Form 5S (3Δ 2CT) .....	47
Form 5S (3Δ 2CT 2VT) .....	48
Form 5S (4Δ 2CT ) .....	49
Form 5S (4Y 3CT) .....	50
Form 5S (4Y 3CT) .....	51
Form 5S (4Y 3CT 2VT) .....	52
Form 12S (25S) (3N) .....	53
Form 12S (25S) (3Δ) .....	54
Form 35S (3Δ) .....	55

Form 45S (4Δ 2CT).....	56
Form 45S (4Y 2CT 2VT).....	57
<b>Appendix C</b>	
Form Configurations .....	59
<b>Appendix D</b>	
Troubleshooting .....	61
<b>Appendix E</b>	
Customer Service .....	63
<b>Appendix F</b>	
Recommendations .....	65

# List of Abbreviations

Abbreviation	Complete term
A	Ampere
Amp	Ampere
AC	Alternating current
AP	Access point
ATK	Accuracy Testing Kit
CFM	Cubic feet per minute
CL	Class
CSV	Comma-separated values
CT	Current transformer
DSP	Digital signal processor
HL	High load (full load)
Kh	Watt-hour constant. The number of watt-hours represented by one revolution of the disk. Also called disk constant.
Kt	Test constant. For electronic (no disk) meters, the amount of energy represented by each calibrated pulse of the LED.
kW	Kilowatt
Lb.	Pound
LL	Light load
NIST	National Institute of Standards and Technology
PF	Power factor
PPI	Pore per inch
Rev	Revolution, number of revolutions
RMS	Root mean square
TA	Test ampere
THD	Total harmonic distortion
V	Volt
VA	Volt-ampere
VAC	Volt(s) of alternating current
VARh	VARhour (volt-ampere reactive hour)
Vdc	Voltage direct current
VT	Voltage transformer
W	Watt(s)

<b>Abbreviation</b>	<b>Complete term</b>
Wh	Watt-hour
WiFi	Wireless fidelity
WLAN	Wireless local area network
WWW	World Wide Web
$\mu$ Wh	Micro-watt-hour
$\mu$ VARh	Micro-VAR-hour

---

# Chapter 1

## Introduction

---

The Probewell Lab MT-1/WT1 is a portable single-phase meter tester with built-in WiFi technology.

### MT-1/WT1 Overview

---

The MT-1/WT1 test socket adapter weighs only 6.4 lb which makes it the ideal tool for field testing. With the MT-1/WT1, meter technicians can accurately test residential, commercial or industrial electricity meters on site in mere minutes.

The MT-1/WT1 can be set to test single-phase meters in one step (Quick Test) or set to test the two phases simultaneously, followed by each element separately (Full Test). The MT-1/WT1 provides measurements for active and reactive energy with forward and reverse flow testing capability.

The MT-1/WT1 has a built-in two-phase phantom load consisting of synthesized 50 A current sources and a two-phase electronic standard with a typical accuracy of  $\pm 0.02\%$  and a guaranteed accuracy of  $\pm 0.05\%$ . It comes with a complete calibration report certifying measurement accuracy across its entire operating range.

The MT-1/WT1 comes with a shock-resistant carrying bag. The bag has individual compartments for the test socket, the pickups, the update cable and the User Guide. There is also enough space for small accessories, such as the magnetic adapter for the optical pickup, seals, pliers, etc.

Optional: A handheld remote is available for the MT-1/WT1. It has a keypad and an LCD display and weighs only 0.6 lb.





---

# Chapter 2

## Description

---

The first part of this chapter describes the MT-1/WT1 socket. The second part explains the theory of operation for the tester.

### MT-1/WT1 Socket

---

The MT-1/WT1 socket is cylinder-shaped, designed to be easily inserted in both ringless and ring-type meter bases. A latch with a quick-release mechanism is available as an option for ring-type meter bases.

The socket contains two 50 A synthesized AC current sources to simulate resistive and reactive loads, a high accuracy two-phase electronic standard and a WiFi communication controller.

The rear of the socket has four standard fixed tabs with bypasses and two removable twist tabs, with twist-and-lock mechanism. The socket gets its power directly from these back tabs and accepts an input voltage from 100 to 600 VAC.

The twist tabs can be placed at the 3, 5, 6 or 9 o'clock position as required by the meter base where the test is being conducted. See Appendix C for all twist tab configurations.

The front of the socket has eight jaws and two spring-loaded contact pistons. The pistons are actuated by the meter's middle lugs. The meter under test is entirely controlled by the socket. No setup wiring is needed.

The socket has a dead-front design for safer operation. The front jaws of the socket only become live when a meter is inserted. See Appendix A for all technical specifications.

## Front/Rear View of the Socket

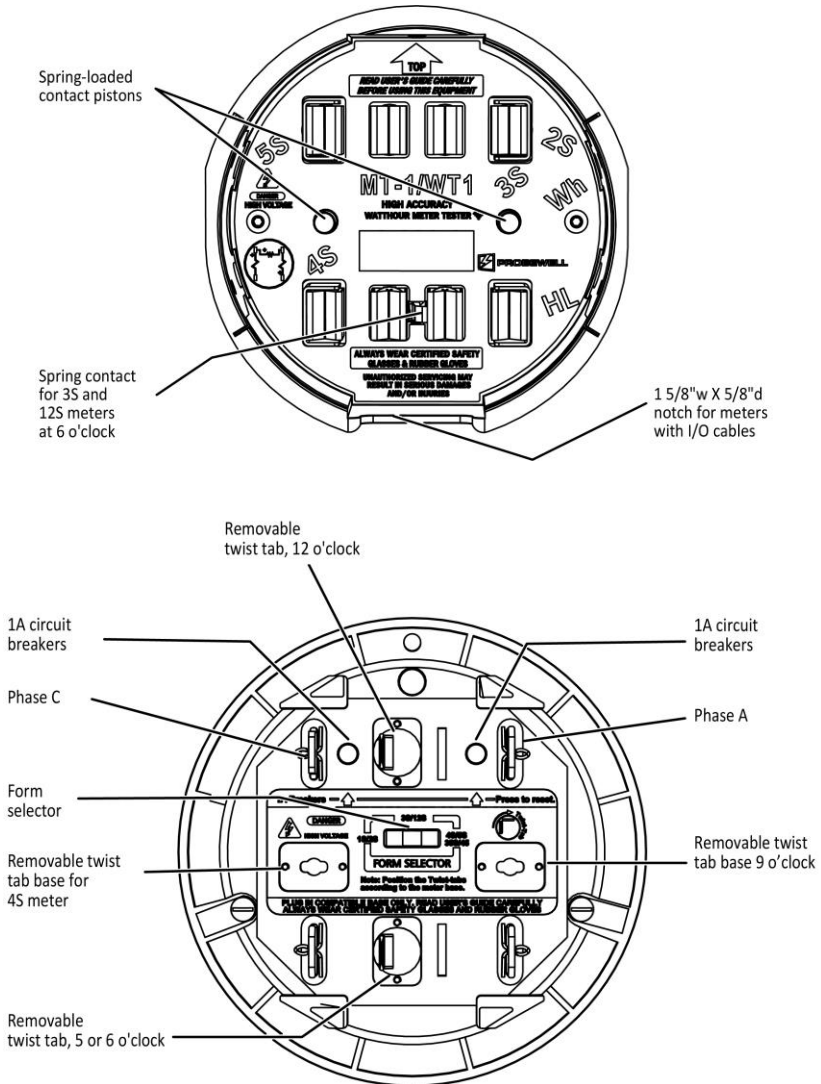

**Fig. 2.1 – Front and Rear View of the Socket**

Fig. 2.1 shows the removable twist tabs, which do not require any tools to move from one position to another. The above illustration shows the twist tabs positioned at 6 and 12 o'clock.

## Side View of the Socket

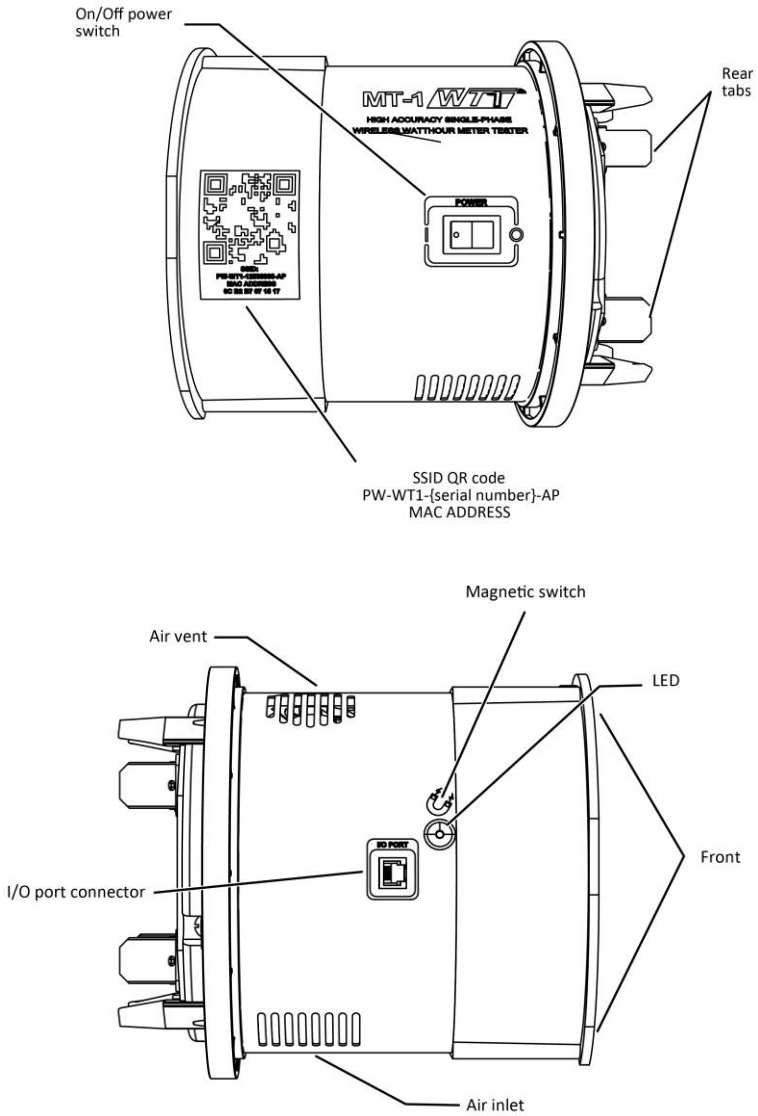

Fig. 2.2 – Side View of the Socket

Identification	Description
Rear tabs	The rear tabs connect the socket to the front jaws of the meter base. The socket gets its power directly from the meter base (100–600 VAC) circuit. The service current shorting bars (bypasses) are rated for high-capacity amperage.
Removable tabs	These tabs can be positioned at the 3, 5, 6, 9 or 12 o'clock position as required by the meter base where the test is being conducted. See Appendix C.
Form Selector	In position 1S/2S, the unit is powered from the two upper tabs. In position 3S/12S, the unit is powered from Phase C and the neutral tab. In position 4S/5S/35S/45S, the unit is powered from the 3 and 9 o'clock tabs for 4S and from the 5 and 12 o'clock tabs for 5S, 35S and 45S.
Circuit breakers	Protection for the MT-1/WT1 and the meter. Two 1 A circuit breakers, which can be reset by pressing a spring-loaded button.
Power switch	Socket's main power On/Off switch.
Front jaws	The front jaws are controlled by internal relays used to test the meters. The front jaws only become live when a meter is inserted. The voltage on the front jaws is current-limited for additional protection.
Pistons	These are actuated by the small lugs on the back of the meter when inserted for testing.
I/O connector	Isolated full-duplex communication port. It also provides an isolated and current-limited low-voltage supply for the accessories (Optical Pickup and Metercam) and the optional handheld remote control.
QR code sticker	The QR code sticker contains the access point information to be scanned for a mobile device as well as the MAC address.
LED	Socket status indicator.
Magnetic switch	Switch for any manual entry using a magnet.
Air vent <sup>(1)</sup>	Warm air exit. A 5 CFM miniature fan forces air circulation inside the socket.
Air inlet <sup>(1)</sup>	Cool air input. Filtered through a polyurethane foam filter.
<sup>(1)</sup> Do not block air circulation. Keep away from direct heat or flame.	

## Theory of Operation

---

MT-1/WT1 applies a load to the meter under test, then measures the exact quantity of energy that passes through the meter. After a predetermined number of disk revolutions, or a minimum time in the case of a solid-state meter, the test will end, and the application (Probewell Connect) will display the difference between the meter and the MT-1/WT1's internal electronic standard.

### Current Applied to the Meter

The current applied to the meter under test is achieved by two independent built-in 50 A synthesized AC current sources. The current level is adjustable and regulated. The current sources simulate loads at unity and at a lagging power factor of 0.5. They are isolated and form three independent current loads in closed-link arrangement. This configuration makes it possible to check a meter without needing to open its potential link and setting up any wiring.

### Voltage Applied to the Meter

The voltage applied to the front jaws is derived from the meter base circuit. For safety reasons, the voltage is only applied to the front jaws when a meter is inserted. The voltage is also current-limited.

The front jaws of the MT-1/WT1 are controlled by internal relays used to test self-contained and CT-rated single-phase watt-hour meter form configurations with no wire setup necessary.

### Built-in Electronic Standard

The MT-1/WT1's built-in electronic standard offers exceptional accuracy thanks to the use of electronic transducers developed by Probewell. These transducers have an exceptional long-term stability and linearity and are not affected by temperature.

The electronic standard does not contain any potentiometers or other types of screw adjustment that could become unstable with time. It uses digital technology to ensure maximum reliability over time. A DSP processor measures and calculates the exact energy, active or reactive, that passes through the meter. This technology has the advantage of a more compact and lightweight electronic standard, with smaller, lighter electronic components.

### Accuracy Test

The MT-1/WT1's electronic standard is calibrated using a primary standard traceable to NIST and comes with a complete calibration report certifying measurement accuracy on both Wh and VARh scales over its entire operating range. Accuracy tests on MT-1/WT1 can be conducted in your own laboratory using:

- An electronic reference standard traceable to NIST. The electronic standard must have at least one isolated current input port of a minimum capacity of 50 A with autoranging capability and a typical precision of 0.01% or better.
- A laboratory-stabilized and -isolated AC power source with fundamental waveform selectable 120 V or 240 V, 60 Hz, rated at least 150 VA.
- The Accuracy Testing Kit (ATK-4) for single-phase testers.

For more information on the socket accuracy test, please refer to the ATK and Probewell Connect for WT series documentation.

## Meter Testing

---

### Tests performed with a pickup (Optical or Metercam)

Five different tests can be performed with optical pickups: Quick, Full, Custom, Four-Quadrant (Wh) and Four-Quadrant (VARh).

**Quick Test, Full Test, Four-Quadrant (Wh) Test and Four-Quadrant (Varh) Test** are made up of a predetermined sequence of consecutive steps and tests, all of which are performed in a single operation. The sequence is programmable and can be modified through the “Settings” tab. By default, the sequence includes one test point for each of the loads: HL, PF and LL.

In **Quick Test**, the two phases (A+C) are tested simultaneously in one step.

In **Full Test**, a Quick Test is conducted, followed by each phase (A and C) tested separately. In the “Settings” tab, there is an option to remove the PF and/or LL for each single-element test.

In **Four-Quadrant (Wh) Test**, the equivalent of a Quick Test is conducted at various phase lags between voltage and current. This is meant to test the meter’s operation in all four quadrants of the power vector diagram. For this test, the device expects the meter to pulse on Wh units.

In **Four-Quadrant (VARh) Test**, the equivalent of a Quick Test is conducted at various phase lags between voltage and current. This is meant to test the meter’s operation in all four quadrants of the power vector diagram. For this test, the device expects the meter to pulse on VARh units.

Please note that with single-phase meters, only the Quick Test, Four-Quadrant (Wh) Test and Four-Quadrant (VARh) Test will be activated as there is no Full Test for single-phase meters.

**Custom Test** consists of choosing one of the three loads to apply to the meter: HL, PF or LL. The pickup automatically counts the disk revolutions or pulses. No critical timing is required to start a test. The test ends automatically.

When testing a polyphase meter, you can also choose to apply the load on all phases (AC) at the same time or on each phase individually (A or C). Select the appropriate phase (A, C, or A+C) in the “Select Active Phase” drop-down window.

### Tests performed without a pickup (Optical or Metercam)

**Manual Test** is when the operator counts the disk revolutions manually. The test is started and stopped manually by applying a magnet to the side of the socket (see Figure 2.2). Operators can set their own parameters for conducting a test, such as the number of revolutions and the load to be applied. The load can be switched dynamically during the test.

Please note that without the help of a pickup, if the operator signals the start or the end of a test with the magnet too early or too late, the number of disk revolutions (whole number, no fractions) may not be accurate and will affect the test’s precision.

**Tracking Test** is similar to Manual Test, except that the socket counts the number of revolutions and displays them on your wireless device. The count is based on the selected Kh for the meter and the cumulative wathours recorded by the MT-1/WT1,



not the physical count of the disk revolutions. A magnet can be used to start and end the test.

**kW Demand** Test allows the operator to perform a kW demand test. The test is calculated using this formula:

$$\text{kW} = \text{kWh} \times 60/T$$

Where T = Demand interval length in minutes

**Note:** With solid-state metering, conducting energy and demand tests may be considered redundant since they are both results of the same measurement.

Set up the meter for a kW demand test following the manufacturer's instructions. Please note that instructions for conducting kW demand tests will vary by manufacturer, as per their respective technical guides.

**Line Monitor Test** analyzes the input voltage to statistically determine the line voltage, frequency fluctuations and its harmonic content (THD) up to the 32nd order.

**KYZ Test** is used to verify the KYZ or KY meter's output pulses.

## Accessories

### Metercam

The Metercam is used with electromechanical (rotating disk) meters. It is a digital disk sensor without the many drawbacks of most photoelectric sensors, such as difficulty in aligning properly and sensitivity to light. With the Metercam, no alignment is necessary since it detects and picks up the disk by itself. Another feature is its electronic shutter, which makes it impervious to light variations, including bright sunlight.

The Metercam is built around a miniature digital camera with a ½" field view combined with a RISC processor that detects the meter disk's position and automatically locks onto the reference point (black flag).

The Metercam is mounted on four suction cups installed directly on the back.

For a secure and lengthy hold, lightly moisten the inside of the suction cups, especially when field testing in colder weather. Also, keep the inside of the suction cups clean.

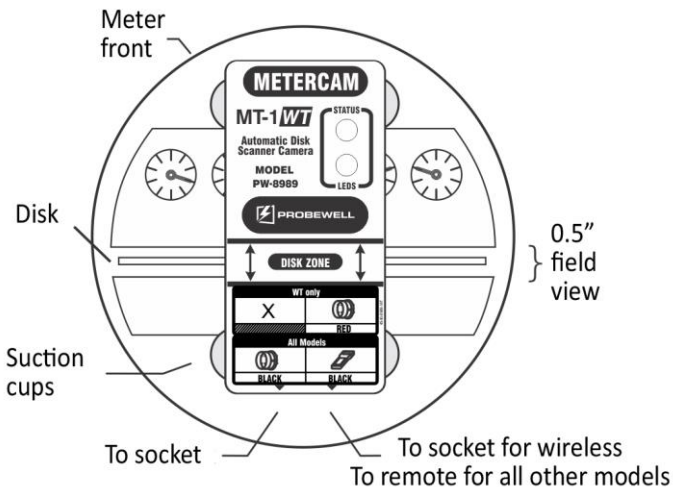

Fig. 2.4 – Metercam

**Note:** A side-mount Metercam is available for electromechanical meters with a hidden disk.

## Optical Pickup

The Optical Pickup is used with solid-state meters. It is mounted with a suction cup or integrated in a magnetic head that detects infrared light pulses generated by solid-state meters. The optical pickup uses edge triggering for less sensitivity to changes. On the top of the pickup's head, there is a pulse indicator in the form of a visible red LED that flashes when pulses are being received.

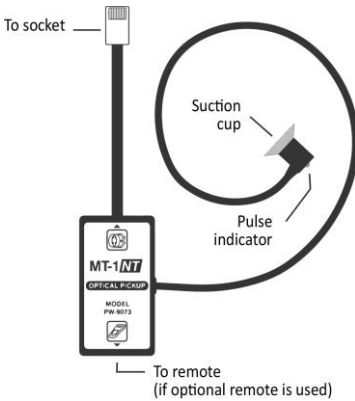

Fig. 2.5a – Optical Pickup

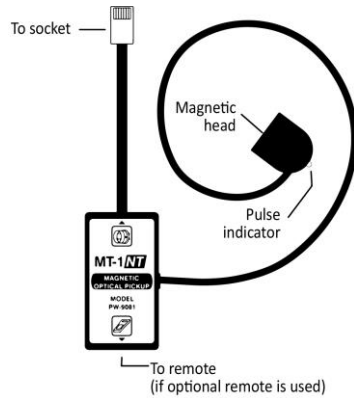
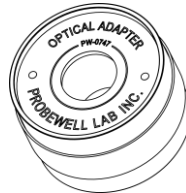

Fig. 2.5b – Magnetic Optical Pickup

## Adapters



The **Focus Adapter** is used with the Optical Pickup for meters with a protuberant shape over the test pulse.



The **Magnetic Adapter** is used to affix the Optional Pickup's suction cup on meters with a metallic port.

## Meter Adapters

---

**Sensus 3S:** This adapter is used to test Sensus' 3S meter. The meter will be damaged if this adapter is not used.



---

# Chapter 3

## Operation

---



### CAUTION!

MT-1/WT1's use is strictly reserved for personnel authorized to manipulate electric installation meters. For safety reasons, *certified safety glasses and rubber gloves* are strongly recommended, but are not provided with the MT-1/WT1.

The operation of removing and inserting a meter from its meter base under power exposes live electric terminals. **Use utmost caution. Do not stick your hands or any metal objects into the open meter base. You could suffer bodily burns, electric shocks and even electrocution.**

It is imperative that you **follow your company's safety procedures.**

---

## Summary

---

The MT-1/WT1 is compatible with meter forms 1S, 2S, 3S, 4S, 5S, 12S, 35S and 45S. Before testing a meter in the field, always make sure the meter base's electrical wiring is fully compatible with that shown in Appendix B.

The MT-1/WT1 socket must first be inserted between the meter base and the meter. The installation procedure for a ringless meter base is described hereafter in Fig. 3.1.

When powered on, the MT-1/WT1 recognizes the type of meter installed and validates the form and the TA required. With some meters, it is sometimes necessary to select the form manually.

When a pickup (Optical or Metercam) is used, the socket detects the meter's Kh and uses it. If for some reason the suggested Kh does not match the Kh indicated on the meter, the operator can change it manually by restarting the socket and disabling "Kh autodetection." If not using a pickup, the operator must manually enter the meter's Kh.

The next step is to choose a type of test to perform.

If a pickup is used, testing becomes fully automatic and the available test modes are: Custom, Quick, Full, Four-Quadrant (Wh) and Four-Quadrant (VARh).

If not using a pickup, the available test modes are: Manual and Tracking. In Tracking, the test is conducted manually and the meter disk (or simulated disk for solid-state meters) must complete a precise number of revolutions. It is up to the operator to start and stop the test at the right time by pressing "START/STOP" or using the magnetic switch on the side of the socket.

Once the load is applied and the test has started, the MT-1/WT1 measures the energy that passes through the meter with its internal electronic standard. All the important measurements are shown on the mobile device or computer display while testing.

When the test ends, the test result is displayed in percentage error (e.g. -0.02%) or in percentage registration (e.g. 99.98%).

\*The Four-Quadrant (Wh) and the Four-Quadrant (VARh) test are only available for electronic meters with an optical pulse.

# Installing the Socket

---

## 1. Removing the Meter



### WARNING:

Do not remove the meter when it is under a heavy load to avoid sparks. The front jaws of the meter base are live. **Do not stick your hands or any metal objects into the meter base! Certified safety glasses and rubber gloves are strongly recommended.**

Carefully remove the meter from its base **according to your company's safety procedures**. Avoid removing the meter under heavy load as it may cause sparks. Before removing the meter from a CT-rated meter base, **be sure to short the secondary CTs to prevent equipment damage and personal injury.**

Make sure the wiring connecting the meter to the line is compatible with one of the configurations shown in Appendix B. If not compatible, stop here and put the meter back into place. Field-testing with the MT-1/WT1 is not possible for that meter installation.

## 2. Installing the MT-1/WT1 Socket<sup>1</sup>

Make sure the MT-1/WT1 socket's power switch is set to "Off." Check Appendix B to set up the twist tabs and the Form Selector before inserting into the meter base. For ringless meter bases, remove the latch if necessary, using the quick-release mechanism.

Hold the MT-1/WT1 socket firmly, with the arrow pointing upward and align the socket's rear tabs with the meter base's front jaws. Then firmly insert the MT-1/WT1 socket into the meter base. Secure the installation. For ring-type meter bases, a latch can be purchased as an option.

---

<sup>1</sup> When the MT-1/WT1 is used in the meter shop, do not plug into a test board. It will not run properly. You can use a single-phase four-jaw meter base with a capacity of at least 150 VA. Keep the Form Selector in the 1S/2S position for all meter types. The nominal voltage must be respected according to the meter being tested.



### 3. Installing the Meter

Plug the meter into the front of the MT-1/WT1 socket. If I/O cables are present, place them into the notch before inserting the meter. Make sure everything is well-secured. The socket installation is complete. Operation examples are provided further on.

#### Installation Procedure (ringless meter base)

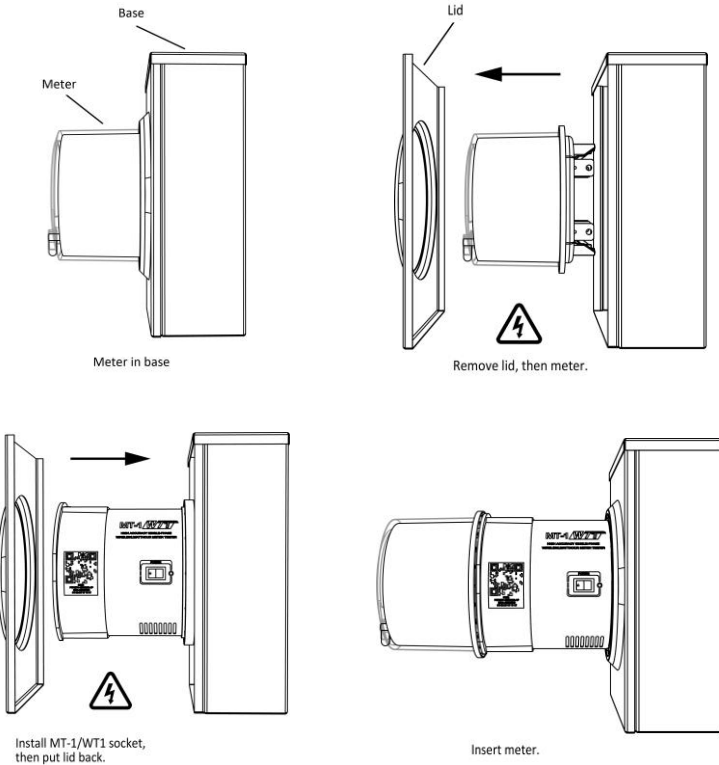

Fig. 3.1 – Installation – Ringless Meter Base



**THIS SYMBOL INDICATES THAT VOLTAGE IS PRESENT AND EXTREME CAUTION SHOULD BE USED.**

**ONLY INSTALL THE MT-1/WT1 SOCKET IN COMPATIBLE METER BASES. SEE APPENDIX B FOR COMPATIBILITY.**

## Connecting to the MT-1/WT1

---

This section explains how to connect to the MT-1/WT1 over WiFi for a quick start. For more detailed information, please refer to the Probewell Connect for WT Series documentation.

### Setting up the connection

First, power up the MT-1/WT1 with the “On/Off” switch.

#### Probewell Connect for IOS and Android

Open the application on your mobile device.

How to get the app:  
For iOS: Go to the Apple App Store.  
For Android: Go to Google Play Store.  
Search for “Probewell Connect.”

Scan QR for a first use or select known socket SSID.

#### For a Probewell Connect App for Windows 10<sup>1</sup>

Go to “Windows Settings.”

Select “Network & Internet.”

Click on “Show available networks.”

Locate the socket SSID within the available networks list.

Input the SSID name as the security key. (i.e., PW-WT1-{S/N}-AP). This number is located under the QR code on the side of the tester.

Wait to be connected to the socket.

Start the Probewell Connect\* application from your computer.

#### Note

When the procedure has been completed once, the SSID will be accessible directly from the network list.

Probewell Connect for Windows is downloadable from our website.

[\(https://probewell.com/pw-connect/\)](https://probewell.com/pw-connect/)

## Running the Application

---

Please refer to the Probewell Connect User Guide.

---

<sup>1</sup> We recommend Windows 10; other versions are not being tested.

## Available Tests

---

- **Quick:** Tests all phases simultaneously with all loads (HL, PF, LL).
- **Custom:** Tests all phases simultaneously with only one load selected by the operator.
- **Full:** Performs a Quick Test and all phases separately (only available with polyphase meters).
- **Four-Quadrant (Wh):** Performs a Quick Test at various phase angle lags between voltage and current to test operation in all four quadrants. The measurements are in Wh.
- **Four-Quadrant (VARh):** Performs a Quick Test at various phase angle lags between voltage and current to test operation in all four quadrants. The measurements are in VARh.
- **Manual/Tracking:** Tests the meter manually, without using a pickup.
- **Line Monitor:** Analyzes the line voltage, the frequency fluctuation and the line voltage harmonic content (THD) up to the 32nd order.
- **Creep:** Performs a creep test.
- **Demand:** Allows the operator to perform a KW demand test.
- **Accuracy:** Verifies against a NIST-traceable electronic standard (only available on the "Settings" page if no meter is installed).

Quick, Custom, Full, Four-Quadrant (Wh) and Four-Quadrant (VARh) test are only available when an optical pickup is installed.

## Test Examples

---

In the following examples, we assume the MT-1/WT1 socket is already installed into the meter base and the meter under test is also plugged into the MT-1/WT1 socket and the installation is well-secured. For more detailed information, please refer to the Probewell Connect for WT Series documentation.

Below are some testing examples included in this manual. The tests are available for all meter types:

1. Quick-Test – 2S solid-state meter
2. Custom Test – 12S solid-state meter
3. Tracking Test – 12S(N) electromechanical meter
4. Custom Test – 2S electromechanical meter
5. Meter tested in a meter shop

Please download the Probewell Connect app to control and take advantage of the meter tester's wireless functionalities.

For more information on how to launch and run the application, refer to the Probewell Connect WT Series User Guide available on Probewell's website.

In the following examples, we assume that the MT-1/WT1 socket is already installed into the meter base and the meter under test is also plugged into the MT-1/WT1 socket and the installation is well-secured.

## Example 1: Quick Test – Solid-State 2S Meter

---

Meter used:	Solid-state, form 2S
Voltage:	120–480 V
Kh:	1.0
TA:	30
CL:	200
Accessory:	Optical Pickup

A **Quick Test** involves applying loads on the meter for at least 20 seconds (the time can be modified) for each load: HL, PF and LL. Please note that the meter's two potential coils are automatically switched in parallel by the socket.

### 1. Connecting the Optical Pickup

To connect the cables:

- Plug the RJ12 connector at the end of the Optical Pickup's straight cable into the socket's I/O port.
- Look for the meter's LED output pulse and position the Optical Pickup's suction cup over it.

**Note:** An adapter may be required on some meters and can be purchased as an option.

### 2. Performing a Quick Test

Once the installation is complete and the connection to the socket and meter setup is done (see previous section), you can proceed with the test.

Select "Quick Test."

Start the sequence. The load current will increase to HL, the meter will start to send pulses and the internal electronic standard will begin to register the energy passing through the meter. The test can be stopped at any time.

In addition to the test parameters appearing on the display, you can see the voltage and current applied to the meter, the chronometer and the cumulated energy registered by the electronic standard.

While testing, you can check the partial results of the test scrolling up and down the screen. You will get the results as they come in.

### 3. Obtaining and Saving the Test Results

After the three test points, the watt-hour measurement period ends automatically. Then, the load is removed and three test results are displayed: one for HL, one for

PF and one for LL. A fourth test result is available: the weight average according to the formula  $(4HL+1LL)/5$ .

The tests results can then be saved.

Before saving, the operator must enter the meter ID, if it was not already entered or scanned, and must answer up to eight custom questions saved in the MT-1/WT1.

Please note that if **Full Test** mode had been selected in this example, the test would have continued, checking each of phases A and C, one after the other under the HL, PF and LL loads.

Note: To speed up the test in Full Test mode, the LL and/or the PF load can be disabled in the "Settings" tab.

In Full Test mode, once all phases (A and C) have been completed and the test for each phase has begun, you can cancel the test at any time by pressing "STOP TEST."

## Example 2: Custom Test – Solid-State 12S Meter

---

Meter used:	Solid-state, form 12S
Voltage:	120 V
Kh:	1.0
TA:	30
CL:	200
Accessory:	Optical Pickup

### 1. Performing a Custom Test

Press **“Custom Test”** in the **“Test”** tab.

Select the load (HL, PF, LL) and the phase.

If you select **“HL”** for all the phases (A+C), the load current will increase to 30 A and the meter will start sending pulses. In the following display, the meter is reading a 7,200 W load (voltage x current x 2)

**Note:** If you want to only test Phase A, select **“Phase A”** in the **“Select active phase”** drop-down window. If you want to only test phase C, select **“Phase C.”**

Press **“START TEST”** to start the test. The meter will send pulses and MT-1/WT1’s internal electronic standard will start measuring the energy sent to the meter.

In addition to the test parameters appearing on the display, you can see the voltage and current applied to the meter, the chronometer and the cumulated energy registered by the electronic standard.

### 2. Test Results

The watt-hour measurement period ends automatically after the default minimum test time, here >20 seconds. Then the load is automatically removed and the test results are displayed.

The test results can be saved by clicking **“YES.”**

You can abort a test at any time by pressing the **“STOP TEST”** button.

### Example 3: Tracking Test – 12S(N) Meter

---

Meter used:	Electromechanical, form 12S
Voltage:	120 V, 3-wire network
Kh:	14.4
TA:	30
CL:	200
Accessory:	None

When “**Tracking Test**” is chosen, it involves applying a 30 A (HL) load for 10 revolutions. No pickup is used for this test. The test can be started and ended with the “START/STOP TEST” button or by using a magnet on the side of the tester (see Figure 2.2).

The meter setup will be displayed on your wireless device with the form 12S and a TA of 30 A. Form 12S will be detected if the meter has the 9 o'clock contact terminal pressed down on the proper piston on the front of the test socket. However, if a meter has a 6 o'clock terminal, the form detected would be 2S. In that case, use the drop-down menu to select form 12S instead of 2S. Once the proper form appears, press “NEXT.”

By default, the selected Kh for a 12S meter is 14.4. It can be changed in the “Tests” tab using “Select meter Kh.” The test is performed over 10 revolutions by default, but you can change this by clicking on the number of revolutions and entering the desired value.

#### 1. Performing a Tracking Mode Test

On the “**Manual Test**” page, toggle the selected mode to “**Tracking**.” In “Rev,” select the desired revolutions. The default setting is 10.

The load current will increase to 3 A and the disk will start to rotate slowly. When the black flag on the disk lines up with the black line (on the meter nameplate), apply a magnet to the side of the socket to start the test and change the current from 3 A to 30 A. At this precise moment, the MT-1/WT1’s internal electronic standard will begin registering the energy passing through the meter.

**Note:** It is easier to start and end a test when the disk is rotating slowly. Press “TOGGLE LOAD” to toggle between HL and LL and vice versa.

On this display, the internal electronic standard measures the energy passing through the meter.

Press on “TOGGLE LOAD.” The current will increase to 30 A and the disk will begin rotating rapidly.

The socket will emit a beep each time the disk has completed one revolution.



On the 9th revolution, the sound of the beep will change to warn that the end of the test is near. Toggle to LL to slow the disk. When the black flag on the disk lines up with the black line, apply the magnet to the side of the socket to end the test.

## **2. Test Results**

The result indicates the meter's accuracy under a 30 A load.

**Note:** It is not possible to save the results of a test in Manual or Tracking mode.

## Example 4: Custom Test – 2S Electromechanical Meter

---

Meter used:	Electromechanical, form 2S
Voltage:	240V
Kh:	7.2
TA:	30
CL:	200
Accessory	Metercam

The **Custom Test** mode involves applying a 30 A load for 10 revolutions. The Metercam is used for this test.

### 1. Installing the Metercam and the Cable

Install the Metercam and the cable:

1. Roughly align the Metercam's 0.5" field view disk zone with the meter disk.
2. Press the Metercam's four corners onto the meter cover hard enough for the suction cups to grip.  
Notes: Make sure that the four suction cups stick perfectly to the meter cover for the entire duration of the test. If necessary, lightly moisten the inside of the suction cups.
3. Insert the red end of the socket's coiled cable into the Metercam's bottom right connector. See Fig. 2.4.

### 2. Disk Detection

Once the unit detects the Metercam's presence, a load is automatically applied to the meter to spin the disk. The Metercam starts the scanning process to detect the meter disk's position. The red LED turns on when the scanning starts. The green LED turns on when the Metercam has found the disk's position. Finally, the red LED turns off when the black flag is found on the disk and turns on only when the black flag passes in front of the Metercam.

Once the Metercam has found the black flag, a self-test is performed automatically to estimate the meter's Kh. If the estimated Kh found is already stored in the remote, it is selected for the test.

### 3. Initialization

On the "Test" page, select "Custom Test" to go to the "Tests" tab.

At the top right of your screen, check that the Kh is 7.2.

#### **4. Loading and Testing**

Press “HL.” The load current will increase to 30 A and the disk will start to rotate. Press “START/STOP” to initiate the test. Measurement will only begin when the Metercam has picked up the black flag and starts to count the disk revolutions. At this precise time, the MT-1/WT1 will start to measure the energy passing through the meter. A double beep will sound, indicating that the test has begun.

In addition to the test parameters appearing on the display, you can see the voltage and current applied to the meter, the chronometer and the cumulated energy registered by the electronic standard.

On this display, the MT-1/WT1’s internal electronic standard shows that it has registered 14.4 Wh (voltage x load x time/3,600) up to now. When calculating Wh, time is expressed in hours.

#### **5. Test Results**

The watt-hour measurement period ends automatically after the 10th disk revolution, i.e. when the Metercam has registered its 10th revolution. The load is then automatically removed to stop the disk and the test results are displayed.

The test results show the meter’s accuracy under a 30 A load.

The results can be saved by clicking “YES.”

Once the results are saved, it is possible to repeat the test at PF or LL.

If you do not wish to save the results, press “CANCEL.” You will be returned to the “Tests” tab. Repeat the test at PF or LL, if desired.

## Example 5: Meter Tested in the Meter Shop

---

The MT-1/WT1 can be used as a test board in the meter shop to check single-phase meters using a single-phase four-jaw meter base mounted on the wall. The meter base must provide a voltage of 120 V or 240 V on the two upper jaws with a capacity of at least 150 VA. **The meter base's voltage must respect the nominal voltage value of the meter under test.**

Before inserting the MT-1/WT1 in the meter base, set the Form Selector switch at the back of the tester to the 1S/2S position so that the MT-1/WT1 is powered from the two upper tabs (see Appendix C). It is recommended to use a holding ring to secure the MT-1/WT1 in place.

Once installed, the test procedure to apply is the same as in the field.



# Appendix A

## Specifications

### General

#### Physical dimensions

Test Socket (Diam. x D)	6.9" x 7.7" (175 x 195 mm)
Carrying Bag (HxLxD)	11" x 11" x 8" (280 x 280 x 203 mm)

#### Weight

Test Socket	5.7 lb. (2.60 kg)
Overall with Carrying Bag	7.6 lb. (3.45 kg)

#### Temperature

Operation	-4 to 140 °F (-20 to 60 °C)
Storage	-4 to 140 °F (-20 to 60 °C)
Humidity	0% to 95% (non-condensing)

#### Optional test accessories

Metercam	Metercam (digital camera disk sensor)
Pulse Pickup	Optical pickup for electronic meters
Magnetic Optical Pickup	Magnetic optical pickup for electronic meters with metallic output pulse
MT-1/ATK-4	Accuracy testing kit
Handheld Remote Control	Optional handheld controller
Latch	To secure the socket to ring-type meter bases
Quick-Release Latch	A quick release to remove the latch from the socket
Focus Adapter	Used with the MT-1/PUL-3 optical pickup for L&G Focus with a triangle output pulse
Magnetic Adapter	Used with the MT-1/PUL-3 optical pickup for meters with metallic output pulse
KYZ device	To monitor the KYZ output for meter equipped with the KYZ feature.

## Test Socket

---

### Input

Voltage	100–600 VAC
Line frequency	58–62 Hz
Power consumption	75VA (maximum)
Bypass circuit	200 A (standard)
Circuit breakers	2 x 1 A (press-to-reset mechanism)

### Output

Voltage	No voltage source is included in the MT-1/WT1.  Line voltage is used for energy measurement. Therefore, the accuracy is less than 200 ppm.
Current	The current sources are designed with a very tight feedback loop to get the most accurate current, therefore the current accuracy is less than 200 ppm.

### Communication

Wireless	802.11 b/g
I/O port	Full-duplex (isolated)

### Meter forms

Single-phase	1S, 2S, 3S, 4S, 12S(N), 25S
Polyphase	5S, 12S, 35S, 45S
Class	CL10, CL20, CL100, CL200, CL320

### Current synthesizers

Channel	2
Adjustable current	0.25 to 50 A
Phase Angle (Wh)	Unity and 60° lag
Phase Angle (VARh)	90° lag and 30° lag

### Voltage applied to meter

Line voltage protected by two 1 A circuit breakers and activated only when the meter is inserted. Voltage is also current-limited.

**Electronic standard accuracy<sup>1</sup>**

Typical	$\pm 0.02\%$
Maximum guaranteed	$\pm 0.05\%$
Influence affecting accuracy	None

**Multifunction measurement accuracy**

RMS voltage	$\pm 0.05\%$ , maximum
RMS current	$\pm 0.05\%$ , maximum
Frequency	$\pm 0.01\%$ , maximum

---

<sup>1</sup> The MT-1/WT1's internal electronic standard is calibrated using a reference standard traceable to NIST and comes with a complete calibration report certifying measurement accuracy for both Wh and VARh scales over its entire operating range. Test accuracy can be checked using a reference standard and the single-phase Accuracy Testing Kit (ATK-4). The calibration of the MT-1/WT1's standard can be slightly changed using the "User Calibration" menu. However, the User Calibration offset is limited to  $\pm 0.05\%$  (in  $\pm 0.001\%$  increments) from factory calibration. User Calibration is stored in the socket's non-volatile memory. The socket contains a unique internal number that identifies its internal electronic standard.





# Appendix B

## Compatible Meter Forms

This Appendix lists all the meter forms compatible with the MT-1/WT1. For each meter form, the electrical service is shown at the top left and an internal schematic of the meter installed is shown at the top right. The wiring that connects the meter to the line and load is also shown. Before proceeding with a field test, make sure that the connections to the socket for a given form are similar to those shown hereafter. The symbols used are:

### Circuit



Current conductor



Voltage conductor



Ground



No connection



Connection

### Meter & meter socket



Current coil



Tab (meter)



Voltage coil



Jaw  
(meter socket)



Circuit-closing device

### Instrument transformer



Current transformer (CT)  
with polarity marks

# Form 1S

## Single-Phase Two-Wire

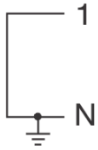

120 or 240 volts

## Form 1S

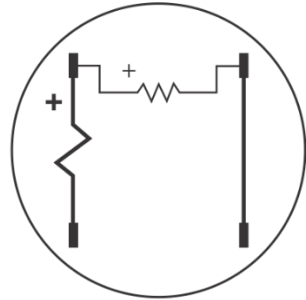

Meter Internal Wiring  
(Front View)

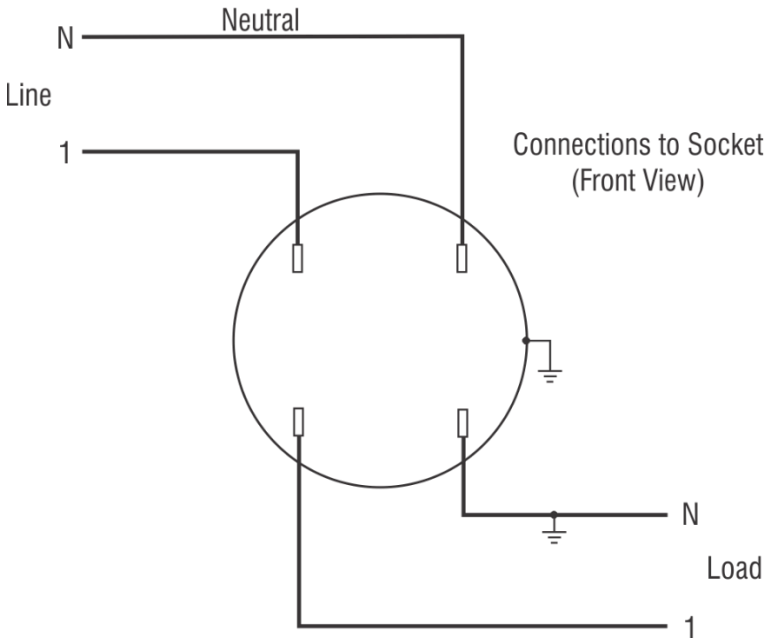

## Form 2S

### Single-Phase Three-Wire

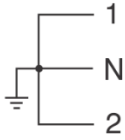

120 volts line-to-neutral  
240 volts line-to-line

### Form 2S

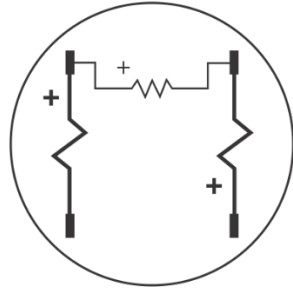

Meter Internal Wiring  
(Front View)

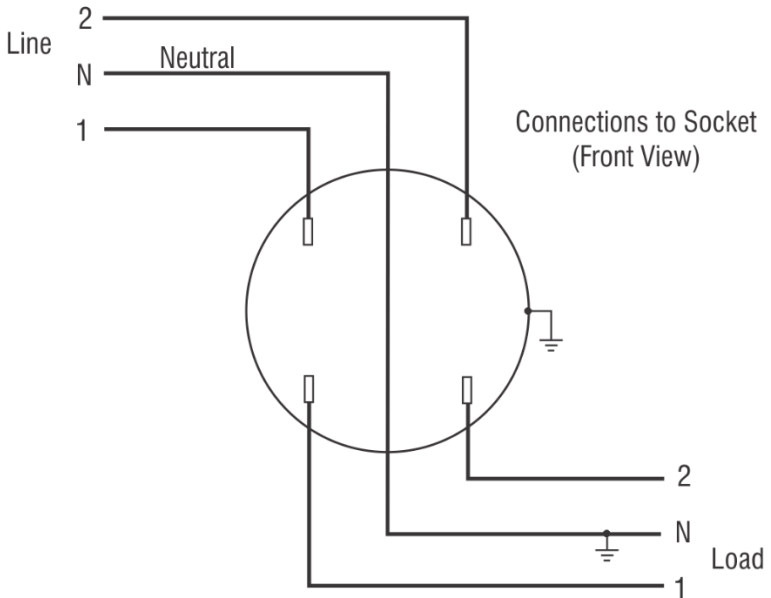

# Form 3S

## Single-Phase Three-Wire With CT

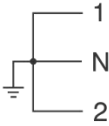

120 volts line-to-neutral  
240 volts line-to-line

## Form 3S

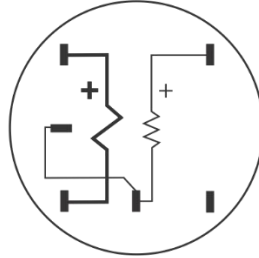

Meter Internal Wiring  
(Front View)

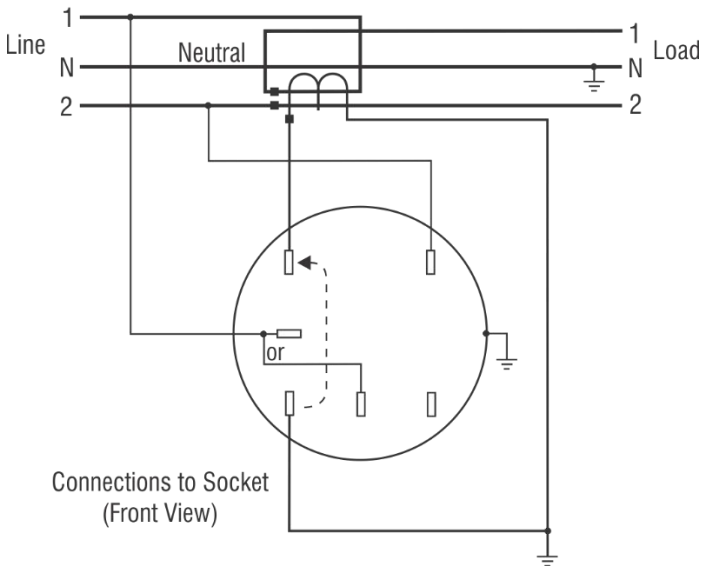

Form 3S single-phase, 120 volts two-wire with CT is also compatible.

**Caution:** Never open a circuit-closing device if current is flowing in the CT primary. Serious personal injury may result.

**Note:** Some older-design 3S, 240 V forms have higher impedance and will not reach full HL when tested with MT-1/WT1. However, the socket will test as high as it can.

# Form 4S

## Single-Phase Three-Wire Two CTs

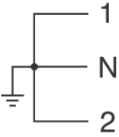

120 volts line-to-neutral  
240 volts line-to-line

## Form 4S

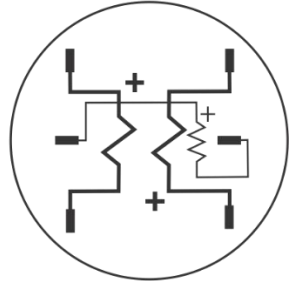

Meter Internal Wiring  
(Front View)

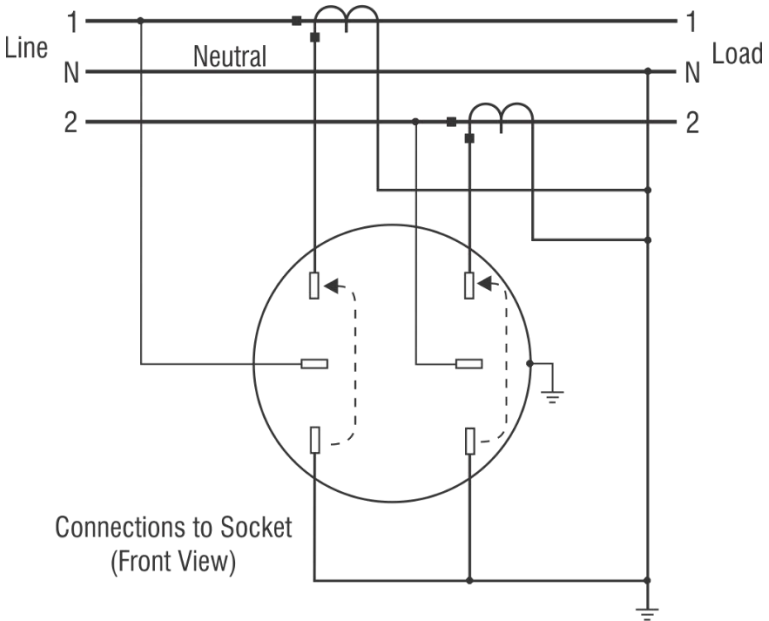

Connections to Socket  
(Front View)

**Caution:** Never open a circuit-closing device if current is flowing in either CT primaries. Serious personal injury may result.

# Form 5S(N) (N 2CT)

## Three-Wire Network With Two CTs

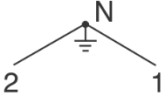

120 volts line-to-neutral  
208 volts line-to-line

## Form 5S

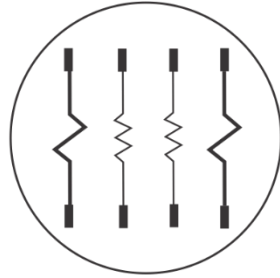

Meter Internal Wiring  
(Front View)

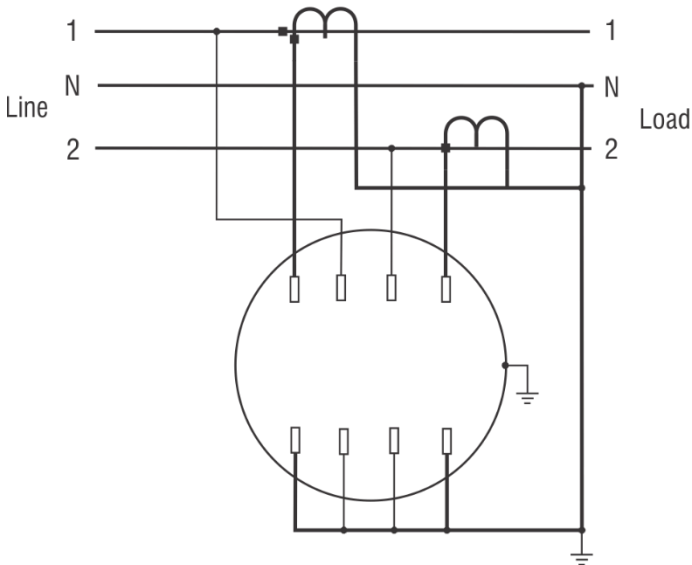

Connections to Socket  
(Front View)

**Caution:** Never open a circuit-closing device if current is flowing in either CT primaries. Serious personal injury may result.

## Form 5S (3Δ 2CT)

**Three-Phase  
Three-Wire Delta  
With Two CTs**

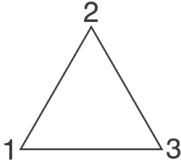

240 volts line-to-line  
or 480 volts line-to-line  
or 120 volts line-to-line

**Form 5S**

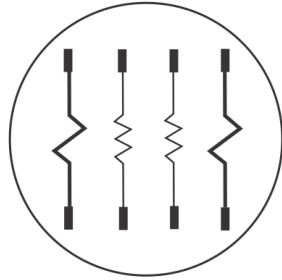

Meter Internal Wiring  
(Front View)

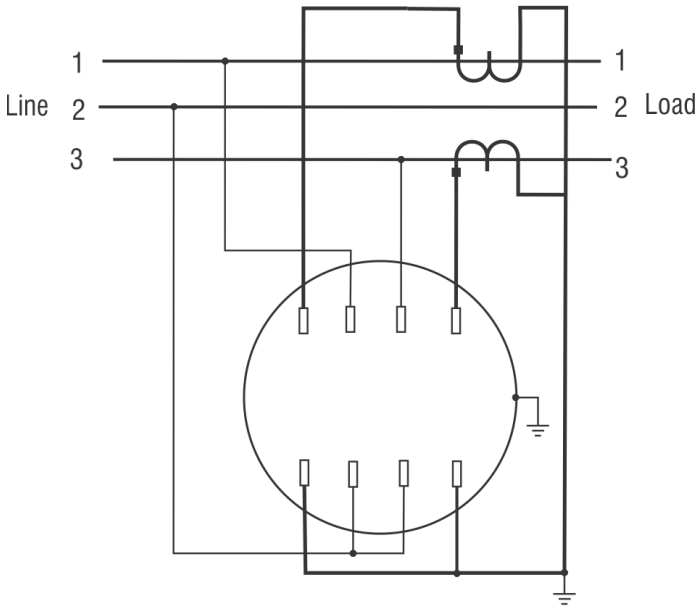

Connections to Socket  
(Front View)

**Caution:** Never open a circuit-closing device if current is flowing in either CT primaries. Serious personal injury may result.



## Form 5S(3Δ 2CT 2VT)

### Three-Phase Three-Wire Delta With Two CTs and Two VTs

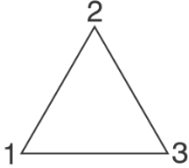

240 volts line-to-line  
or 480 volts line-to-line  
or 120 volts line-to-line

### Form 5S

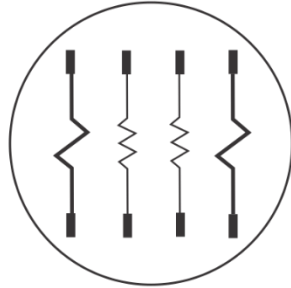

Meter Internal Wiring  
(Front View)

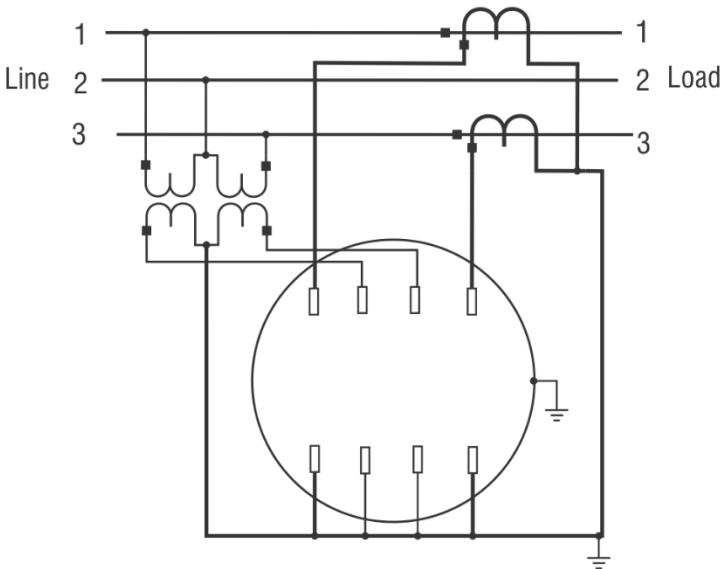

Connections to Socket  
(Front View)

**Caution:** Never open a circuit-closing device if current is flowing in either CT primaries. Serious personal injury may result.

# Form 5S(4Δ 2CT)

## Three-Phase Four-Wire Delta With Two Equal-Ratio CTs

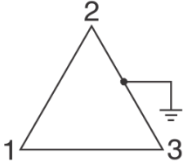

240 volts: 1 to 2, 2 to 3, 3 to 1  
 120 volts: 2 to neutral, 3 to neutral  
 208 Volts: 1 to neutral

## Form 5S

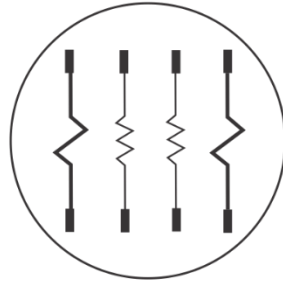

Meter Internal Wiring  
(Front View)

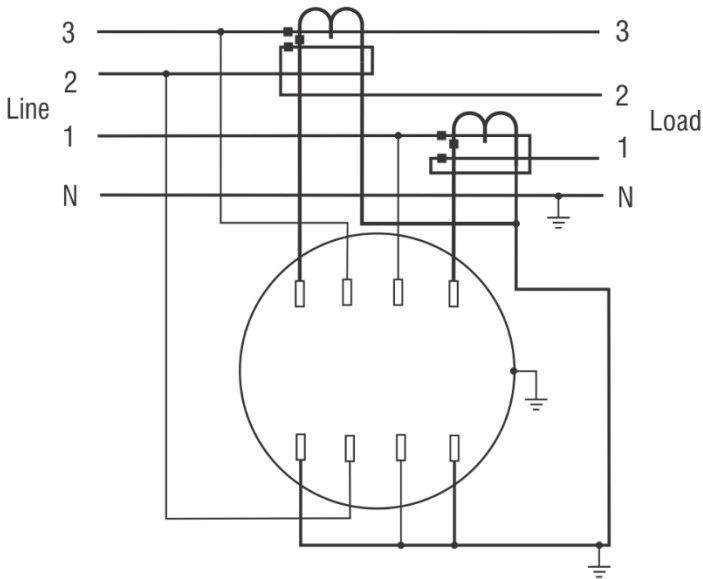

Connections to Socket  
(Front View)

**Caution:** Never open a circuit-closing device if current is flowing in either CT primaries. Serious personal injury may result.

# Form 5S(4Y 3CT)

## Three-Phase Four-Wire Wye With Three CTs

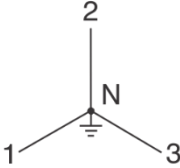

208 volts line-to-line  
120 volts line-to-neutral  
or  
480 volts line-to-line  
277 volts line-to-neutral

## Form 5S

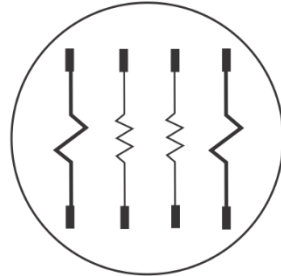

Meter Internal Wiring  
(Front View)

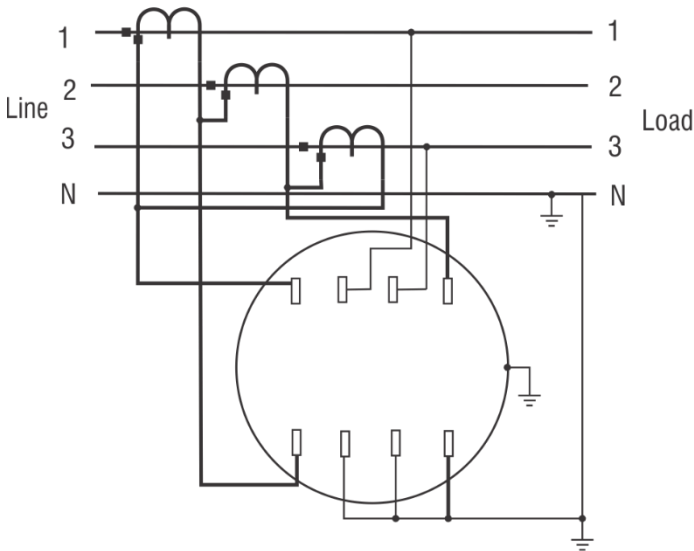

Connections to Socket  
(Front View)

**Caution:** Never open a circuit-closing device if current is flowing in either CT primaries. Serious personal injury may result.

## Form 5S (4Y 3CT)

### Three-Phase Four-Wire Wye With Two Equal-Ratio CTs

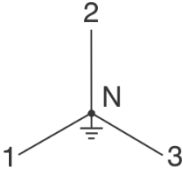

208 volts line-to-line  
120 volts line-to-neutral  
or  
480 volts line-to-line  
277 volts line-to-neutral

### Form 5S

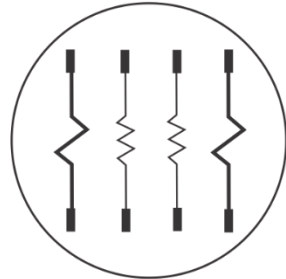

Meter Internal Wiring  
(Front View)

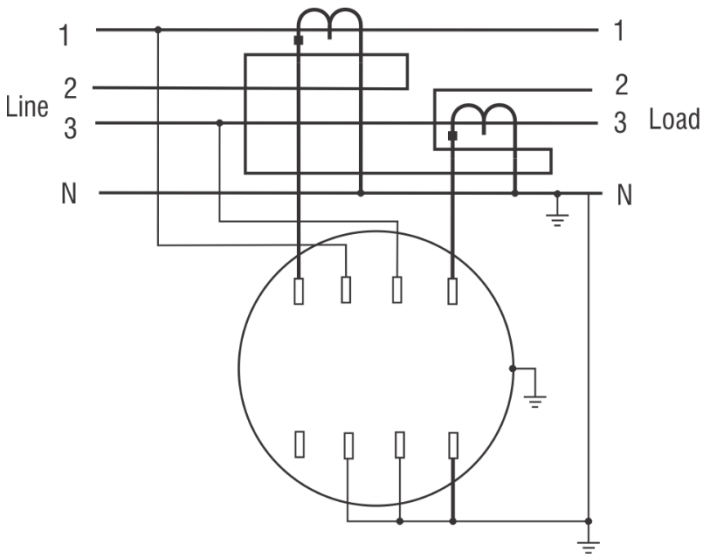

Connections to Socket  
(Front View)

**Caution:** Never open a circuit-closing device if current is flowing in either CT primaries. Serious personal injury may result.

# Form 5S(4Y 3CT2VT)

## Three-Phase Four-Wire Wye With Three CTs and Two VTs

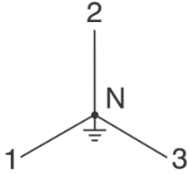

208 volts line-to-line  
120 volts line-to-neutral  
or  
480 volts line-to-line  
277 volts line-to-neutral

## Form 5S

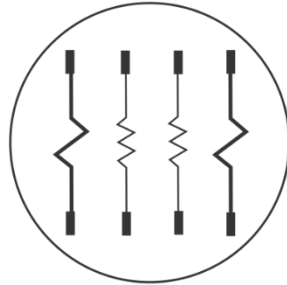

Meter Internal Wiring  
(Front View)

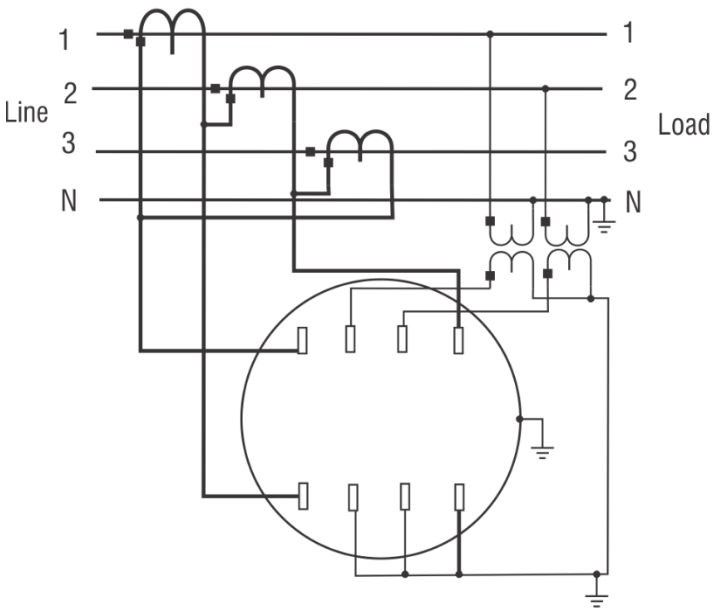

Connections to Socket  
(Front View)

**Caution:** Never open a circuit-closing device if current is flowing in either CT primaries. Serious personal injury may result.

# Form 12S (25S) (3N)

## (N) Network

### Three-Wire Network

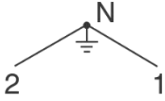

120 volts line-to-neutral  
208 volts line-to-line

### Form 12S

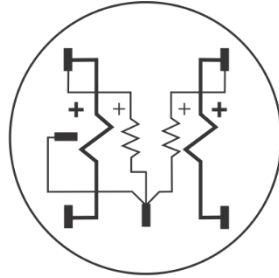

Meter Internal Wiring  
(Front View)

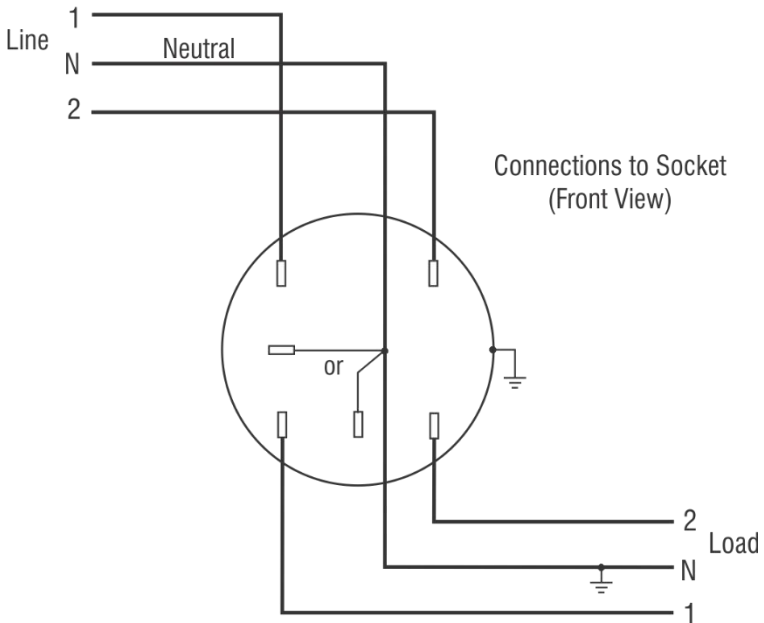

# Form 12S (25S) (3Δ)

## (25S) Delta

### Three-Phase Three-Wire Delta

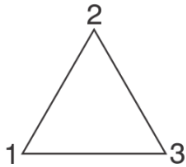

240 volts line-to-line  
or 480 volts line-to-line  
or 120 volts line-to-line

### Form 12S

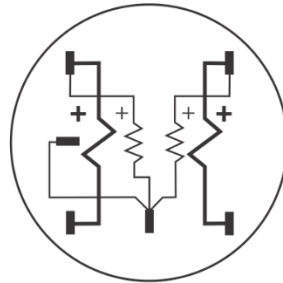

Meter Internal Wiring  
(Front View)

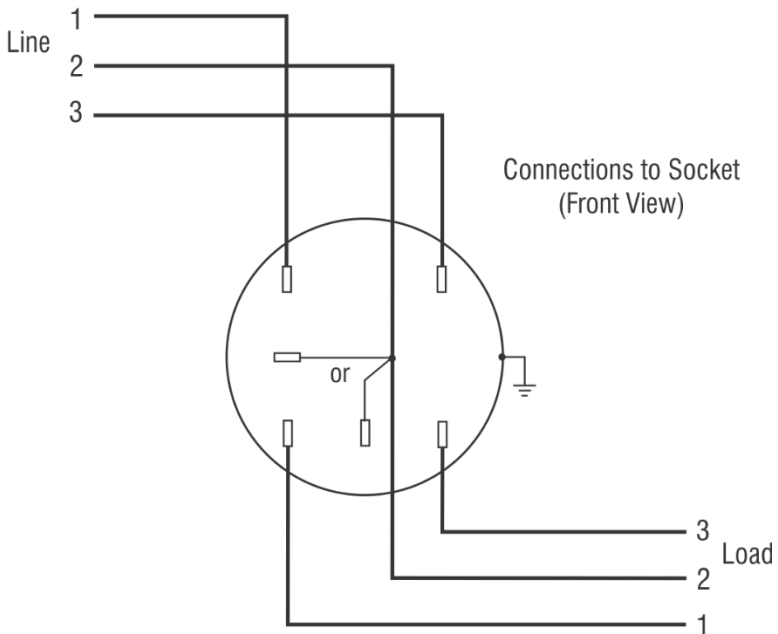

# Form 35S (3Δ)

## Three-Phase Three-Wire Delta

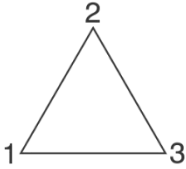

240 volts line-to-line  
or 480 volts line-to-line  
or 120 volts line-to-line

## Form 35S

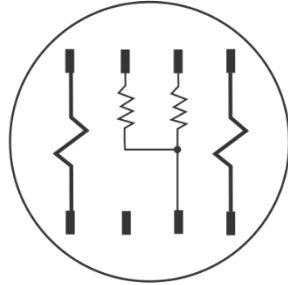

Meter Internal Wiring  
(Front View)

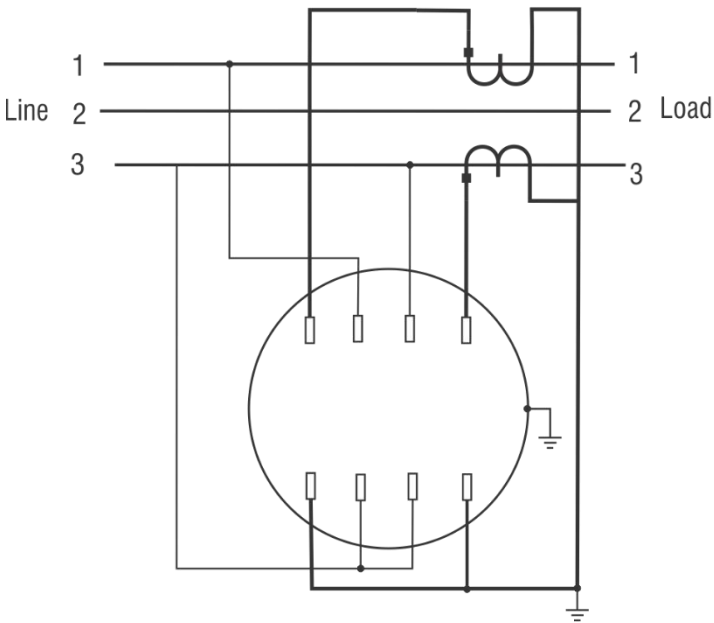

Connections to Socket  
(Front View)



# Form 45S (4Δ 2CT)

## Three-Phase Four-Wire Delta With Two Equal-Ratio CTs

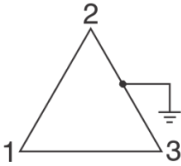

240 volts: 1 to 2, 2 to 3, 3 to 1  
120 volts: 2 to neutral, 3 to neutral  
208 Volts: 1 to neutral

## Form 45S

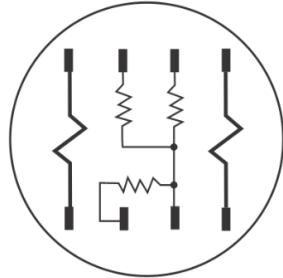

Meter Internal Wiring  
(Front View)

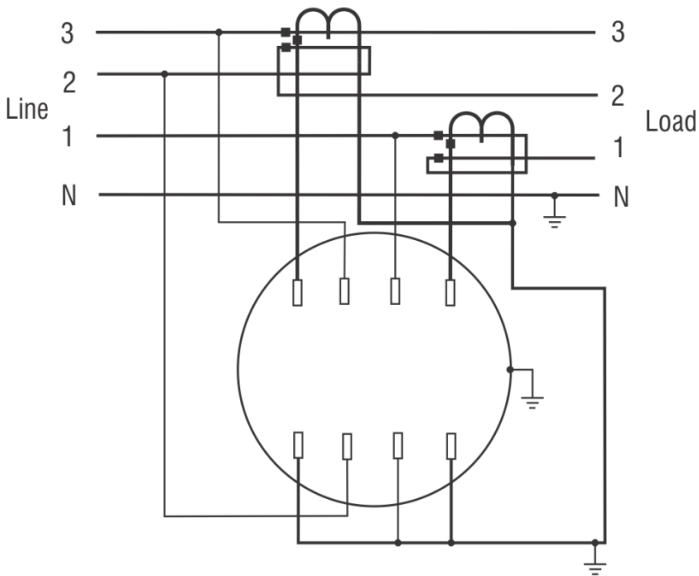

Connections to Socket  
(Front View)

**Note:** To fully test a meter form 45S, you **must** also test it as a 5S.

# Form 45S (4Y 2CT 2VT)

## Three-Phase Four-Wire Wye With Equal-Ratio Cts and Two VTs

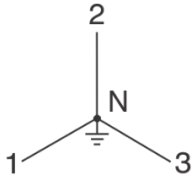

208 volts line-to-line  
120 volts line-to-neutral  
or  
480 volts line-to-line  
277 volts line-to-neutral

## Form 45S

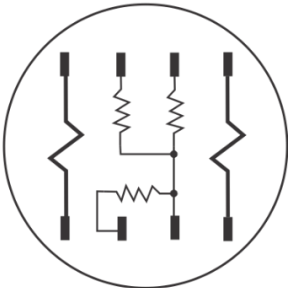

Meter Internal Wiring  
(Front View)

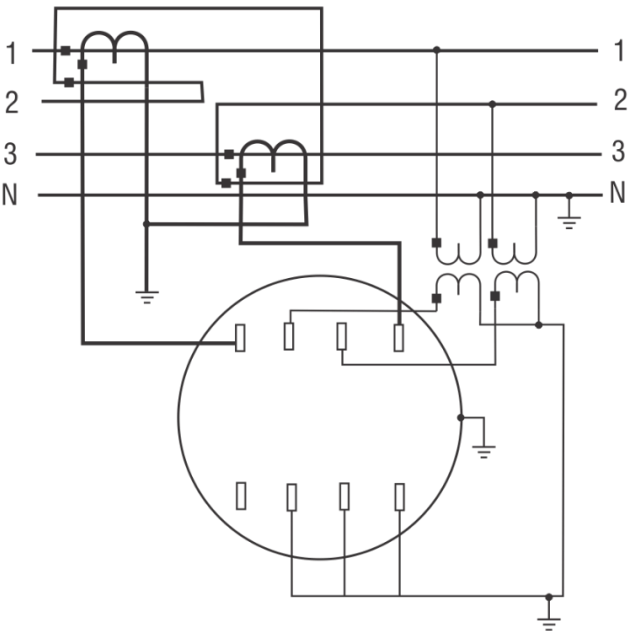

Connections to Socket  
(Front View)

**Note:** To fully test a meter form 45S, you **must** also test it as a 5S.



# Appendix C

## Form Configurations

Below are various back tab configurations for the test socket, depending on the meter base being used.

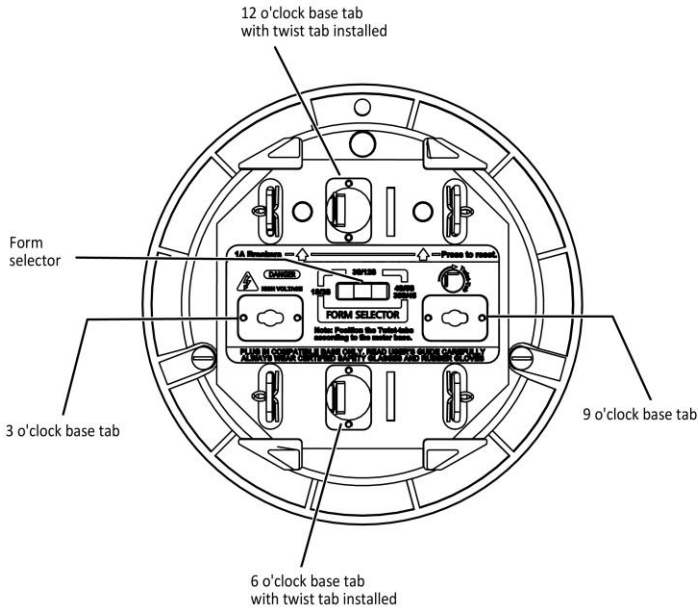

Forms	3 o'clock	12 o'clock	5/6 o'clock	9 o'clock	Form Selector
1S, 2S					
3S 12S, 25S					
4S					
5S 35S, 45S					



# Appendix D

## Troubleshooting

If the MT-1/WT1 seems to be having operational issues, consult the following list to help determine the source of the problem. You can also refer to our support page for more information (<https://probewell.com/support/>). If the problem persists, please contact Probewell Lab Inc.'s technical services.

ISSUE	DESCRIPTION	FIX
<b>SOCKET DOES NOT START AT POWER ON</b>	The socket is not powering on and cannot connect to its web server.	<ul style="list-style-type: none"> <li>• Check if the fan inside the socket is running.</li> <li>• Make sure the Form Selector is set according to the meter base being used.</li> <li>• Verify that the meter base's voltage is between 100 and 480 VAC.</li> <li>• The meter base must be able to provide at least 150 VA.</li> <li>• Do not plug the tester into a test board.</li> </ul>
<b>METER UNDER TEST DOES NOT WORK</b>	The meter is not powering on after the form was selected.	<ul style="list-style-type: none"> <li>• Make sure the selected <b>form</b> matches the one indicated on the meter nameplate.</li> <li>• Turn the MT-1/WT1 off and on again.</li> <li>• Check the meter's insertion.</li> <li>• The meter could be defective. Try another meter.</li> </ul>
<b>NO PULSE FOUND (SOLID-STATE METERS)</b>	On the web interface, you only see "Check meter parameters" and it does not proceed to the "TESTS" page	<ul style="list-style-type: none"> <li>• Make sure the sensor is positioned over the meter's IR pulse emitter.</li> <li>• Some meters need to be set in test mode to emit a proper pulse for testing. See the meter's user manual.</li> </ul>

ISSUE	DESCRIPTION	FIX
<b>METER NOT INSTALLED</b>	The socket is not detecting the meter current elements and the web page interface displays a “meter not installed” message.	<ul style="list-style-type: none"> <li>• Make sure the meter tabs are fully plugged into the MT-1/WT1’s front jaws.</li> <li>• Check if the MT-1/WT1 socket’s front jaws are clean and in good condition.</li> <li>• Check if the meter’s contacts are clean and in good condition.</li> <li>• Try another meter.</li> <li>• Turn the MT-1/WT1 off and on again.</li> </ul>
<b>METERCAM NOT SYNCHRONIZED WITH THE DISK</b>	The Metercam is not detecting the black flag on the disk correctly.	<ul style="list-style-type: none"> <li>• Make sure the Kh corresponds with the one indicated on the meter’s nameplate.</li> <li>• Reposition the Metercam and start the test over again.</li> </ul>
<b>METERCAM KEEPS SCANNING WITHOUT FINDING THE DISK</b>	The Metercam is not detecting the black flag on the disk of the meter being tested.	<ul style="list-style-type: none"> <li>• Check if the disk is turning.</li> <li>• Check if the meter’s disk is in the Metercam diskzone.</li> <li>• Check that the suction cups are adhering properly to the meter face. Lightly moisten the suction cups if necessary.</li> </ul>

---

# Appendix E

## Customer Service

---

### **Warranty and repairs**

If your MT-1/WT1 becomes defective while under warranty (two years after original date of purchase), Probewell Lab Inc. will repair or replace it. If the unit becomes defective after the warranty has expired, Probewell Lab. Inc. will repair it, charging the cost of labor and spare parts.

### **Before returning a unit for repair**

Please do not return your MT-1/WT1 without first contacting customer service at 1-866-626-1126 or sending an email to [info@probewell.com](mailto:info@probewell.com). You will be given detailed shipping instructions.

### **Technical questions**

If you have any technical questions regarding the MT-1/WT1's operation, contact our technical support team at 1-866-626-1126 or send an email to [support@probewell.com](mailto:support@probewell.com).





---

# Appendix F

## Recommendations

---

Probewell Lab Inc. suggests that you respect the following recommendations to get maximum use out of the MT-1/WT1 and its accessories for many years to come. **Any unauthorized modifications or broken seals will immediately void the warranty and any further services.**

### MT-1/WT1

- Do not try to open the MT-1/WT1 socket; there are no serviceable parts inside.
- Never block the air vents on the MT-1/WT1 socket.
- Never expose this equipment to bad weather or direct rain.
- Keep the front jaws and rear tabs clean. Use lubricant for electric contacts. **Do not** use abrasive materials.
- Never use **solvent** to clean the MT-1/WT1. Use a soft moist cloth with non-abrasive soap to clean the surface.
- Handle the MT-1/WT1 with care.

### Metercam and Optical Pickup

- Do not try to open; there are no serviceable parts inside.
- Never expose this equipment to bad weather or direct rain. Do not expose to direct sunlight for long periods of time.
- Keep the Metercam's back window and suction cups clean. **Do not** use abrasive materials. Use a soft moist cloth with non-abrasive soap to clean the surface. Use mineral oil to soften hardened suction cups.
- Handle both pickups with care. Use one of the side pouches inside the carrying bag to store the Metercam and the Optical Pickup.



**Probewell Lab Inc.**  
Printed in Canada  
Edition 2.1

[www.probewell.com](http://www.probewell.com)